

Data Sheet



Article number: 604133030085

Description: Taper bored timing belt pulley
HTD 30 14M 85 TL 2517

Measures

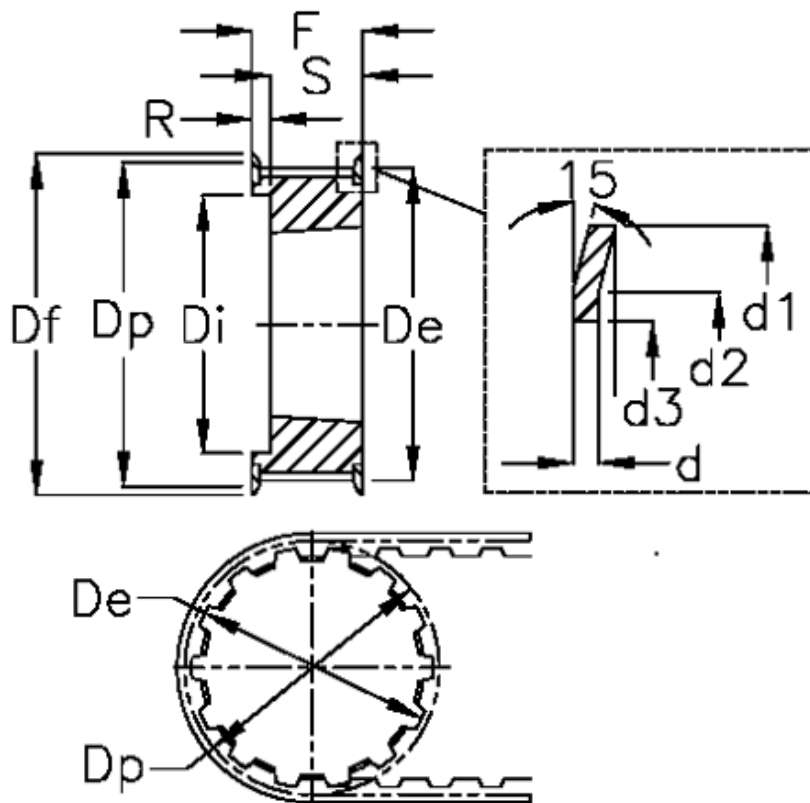

d = 2.5	F = 102	Weight = 3.75
d1 = 138	Flange type = F43	Width = 85
d2 = 132	For bushing = 2517	
d3 = 121	Max bore = 60	
De = 130.99	r = 28.5	
Df = 138	S = 45	
Di = 100	Tooth number = 30	
Dp = 133.69	Type = 14M	